



## Contents

<b>1. Introduction</b>	<b>4</b>
1.1 General information for the users	4
1.2 Manufacturer Warranty	4
1.3 Explosion Proof Warning	3
<b>2. Product Description</b>	<b>5</b>
2.1 General	5
2.2 Main Features and Functions	5
2.3 Label Description	6
2.4 Product Number	6
2.5 Product Specification	7
2.6 Parts and Assembly	8
2.7 Product Dimension	8
2.7.1 YT-2600L	8
2.7.2 YT-2600R	9
<b>3. Installation</b>	<b>9</b>
3.1 Safety	9
3.2 YT-2600L Installation	9
3.2.1 Installation Steps	10
3.3 YT-2600R Installation	12
3.3.1 Bracket Information	12
3.3.2 Installation Steps	13
<b>4. Connections</b>	<b>14</b>
4.1 Safety	14
4.2 Supply Pressure Condition	14
4.3 Piping Condition	14
4.4 Connection – Actuator	14
4.4.1 Single acting actuator	14
4.4.2 Double acting actuator	15
4.5 Connection – Power	15
4.5.1 Safety	15
4.5.2 Terminal Overview	16
4.5.2.1 Input Signal Terminal	16
4.5.2.2 Feedback Signal Terminal	16
4.5.2.3 Limit Switch Terminal	17
4.5.2.4 Ground	17
<b>5. Adjustment</b>	<b>18</b>
5.1 Limit Switch Adjustment	18

5.2 Variable Orifice Adjustment .....	18
<b>6. Operation .....</b>	<b>19</b>
6.1 Safety .....	19
6.2 Button Description .....	19
6.3 Run Mode (RUN) .....	19
6.3.1 Auto Calibration (AUTO CAL) .....	20
6.3.1.1 AUTO1 Calibration (AUTO1) .....	20
6.3.1.2 AUTO2 Calibration (AUTO2) .....	20
6.3.1.3 AUTO3 Calibration (AUTO3) .....	21
6.3.2 Manual Mode (MANUAL) .....	21
6.3.3 Parameter Mode (PARAM) .....	21
6.3.3.1 Dead-Zone (dEAdZONE) .....	21
6.3.3.2 P1 Value (KP1) .....	22
6.3.3.3 D1 Value (Kd1) .....	22
6.3.3.4 P2 (KP2) and D2 (Kd2) Values .....	23
6.3.3.5 P_ (KP_) and D_ (Kd_) Values .....	23
6.3.3.6 PT1 (PT1) and PT2 (PT2) Values .....	23
6.3.3.7 Period T (PERIOD T) .....	23
6.3.3.8 Auto DZ (AUTO dZ) .....	23
6.3.4 Hand Calibration Mode (HAND CAL) .....	24
6.3.4.1 Zero-Point (PV_ZERO) and End-Point (PV_END) for Valves .....	24
6.3.4.2 Zero-Point (TR_ZERO) and End-Point (TR_END) for Transmitter .....	24
6.3.4.3 End-Point Ratio for Valve (PE_TRIM) .....	25
6.3.4.4 Normal / Reverse Feedback Signal (TR_NORM / REV) .....	25
6.3.4.5 Normal / Reverse HART Signal (HT_NORM / REVS) .....	26
6.3.5 Valve Mode (VALVE) .....	26
6.3.5.1 Acting Adjustment (ACT) .....	26
6.3.5.2 Characteristic Adjustment (CHAR) .....	26
6.3.5.3 User Characteristics (USER SET) .....	27
6.3.5.4 Tight Shut Open (TSHUT OP) .....	27
6.3.5.5 Tight Shut Close (TSHUT CL) .....	28
6.3.5.6 Split Range Mode (SPLIT) .....	28
6.3.5.7 Interpolation Mode (ITP OFF / ON) .....	28
6.3.6 View Mode (VIEW) .....	29
<b>7. Error and Warning Code .....</b>	<b>29</b>
7.1 Error Code .....	29
7.2 Warning Code .....	30
<b>8. Main Software Map .....</b>	<b>31</b>

# 1. Introduction

## 1.1 General Information for the users

Thank you for purchasing Young Tech Co., Ltd products. Each product has been fully inspected after its production to offer you the highest quality and reliable performance. Please read the product manual carefully prior to installing and commission the product.

- For the safety, it is important to follow the instructions in the manual. Young Tech Co., Ltd will not be responsible for any damages caused by user's negligence.
- The manual should be provided to the end-user.
- Any modifications or repairs to the product may only be performed if expressed in this manual.
- The manual can be altered or revised without any prior notice. Any changes in product's specification, design, and/or any components may not be printed immediately but until the following revision of the manual.
- The manual should not be duplicated or reproduced for any purpose without prior approval from Young Tech Co., Ltd, Gimpo-si, South Korea.

## 1.2 Manufacturer Warranty

- For the safety, it is important to follow the instructions in the manual. Manufacturer will not be responsible for any damages caused by user's negligence.
- Manufacturer will not be responsible for any damages or accidents as a result of any alteration or modification of the product and its parts. If any alteration or modifications are necessary, please contact Young Tech Co., Ltd directly.
- Manufacturer warrants the product from the date of original purchase of the product for one (1) year, except as otherwise stated.
- Manufacturer warranty will not cover products that have been subjected to abuse, accidents, alterations, modifications, tampering, negligence, misuse, faulty installation, lack of reasonable care, repair or service in any way that is not contemplated in the documentation for the product, or if the model or serial number has been altered, tampered with, defaced or removed; damages that occurs in shipment, due to act of God, failure due to power surge, or cosmetic damage. Improper or incorrectly performed maintenance will void this limited warranty.
- For detailed warranty information, please contact Young Tech Co., Ltd – South Korea.

## 1.3 Explosion Proof Warning

Please ensure the unit is being used and installed within the explosion proof certified environment.

- YT-2600 series explosion proof grade is **Ex d IIC T6** and can be used in **zone 1 and 2**.
- Explosion proof type of cables and gaskets should be used, when explosion gases are



- present at the installation site.
- Power should be turned off completely when opening product's cover. When opening the cover, ensure that there is no power remaining in any electrical parts nearby.
  - YT-2600 series has 2 ports for power connection. Explosion proof type wires and packing should be used. Blind plug is required when any port is not being used.
  - Cable rug with surface area of more than 0.195mm<sup>2</sup> with M4 spring washer should be used to connect the power.
  - For external ground terminal, cable rug with surface area of more than 5.5mm<sup>2</sup> should be used.

## 2. Product Description

### 2.1 General

YT-2600 series Smart Valve Positioner accurately controls valve stroke in response to an input signal of 4-20mA from the controller. Built-in micro-processor optimizes the positioner's performance and provides unique functions such as **Auto-Calibration, PID Control, Alarms, and HART Protocol Communications.**

### 2.2 Main Features and Functions

- LCD display enables users to monitor the positioner status.
- Positioner operates normally during sudden changes in supply pressure and / or high vibration environment.
- Low air consumption level and low voltage use (8.5 V) yield to lower plant operating costs. The YT-2600 is compatible with most of controllers.
- Variable orifice can be used to minimize the hunting occurrence and optimize operating conditions.
- Valve system feedback is greatly improved by the accuracy and fast response of the YT-2600.
- Different valve characteristics can be adjusted – Linear, Quick Open, Equal Percentage, and Custom which user can make 16 points characterizations.
- Tight Shut – Close and Shut - Open can be set.
- PID parameters can be adjusted in the field without any additional communicator.
- A/M switch can be used to direct supply air to the actuator or to manually operate the positioner or valve.
- Split range 4-12mA or 12-20mA can be set.

## 2.3 Label Description



Fig. 1: YT-2600 Body Label

A. Model:	Indicates the model number of the positioner.
B. Supply:	Indicates the supply pressure range.
C. Amb. Temp.:	Indicates the allowable ambient temperature.
D. Input Signal:	Indicates input signal range.
E. Protection of Enclosure:	Indicates protection grade.
F. Explosion Proof:	Indicates certified explosion proof grade.

## 2.4 Product Number

YT-2600	<b>1</b>	<b>2</b>	<b>3</b>	<b>4</b>	<b>E</b>	<b>6</b>	<b>7</b>	<b>8</b>
	<b>1</b>	Motion Type		L	Linear			
				R	Rotary			
	<b>2</b>	Acting Type		S	Single Acting			
				D	Double Acting			
	<b>3</b>	Explosion Proof		C	Ex II B T3 / T5			
	<b>4</b>	Lever Type		L	1	10 ~ 40 mm		
					2	20 ~ 70 mm		
					3	30 ~ 100 mm		
					4	100 ~ 130 mm		
				P	1	M6 34L		
					2	M6 65L		
					3	M6 34L		
					4	M6 65L		
					5	1.4MLP		
	<b>5</b>	Connection Type		1	PT1/2			
				2	1/4PT1/2			
	<b>6</b>	Communicator		C	None			
				1	4-RT Protocol			
	<b>7</b>	Option		C	None			
				1	-RTM			
				2	-LIS			
				3	-RTM & LIS			
	<b>8</b>	Fail Option		F	Fail Freeze			
				S	Fail Safe			

2.5 Product Specification

Model	YT-2600L		YT-2600R	
Acting Type	Single	Double	Single	Double
Input Signal	4~20mA DC			
Minimum Current Signal	3.2mA(Standard), 3.8mA(Hart Included)			
Supply Pressure	0.14~0.7 MPa (1.4~7 bar)			
Stroke	10~150 mm		0~90°	
Impedance	Max.460Ω @ 20mA DC			
Air Connection	PT, NPT 1/4			
Gauge Connection	PT, NPT 1/8			
Conduit Entry	PF(G) 1/2			
Protection Grade	IP66			
Explosion Proof	ExdIICT6*			
Ambient Temperature	Operating Temp. :-30~80°C Explosion Proof Temp. : -30~70°C(T6) / -30~85°C(T5)			
Linearity	±0.5% F.S.			
Hysteresis	0.5% F.S.			
Sensitivity	±0.2% F.S			
Repeatability	±0.3% F.S.			
Flow Capacity	60 LPM (Sup.=0.14 MPa)			
Air Consumption	0.01 LPM (Sup.=0.14 MPa @ idle)			
Output Characteristic	Linear, Quick Open, EQ%, User Set (16 point)			
Vibration	No Resonance upto 100Hz @ 6G			
Humidity	5-95% RH @ 40°C			
Communication (Option)	HART Communication			
Feedback Signal (Option)	4~20mA (DC 10~30V)			
Material	Aluminum Diecasting			
Weight	3.0kg			
Painting	Epoxy Polyestere Powder Coating			



Tested under ambient temperature of 20°C, absolute pressure of 760mmHg, and humidity of 65%. Please contact Young Tech Co., Ltd for detailed testing specification. \* Explosion proof certification is in progress.

## 2.6 Parts and Assembly

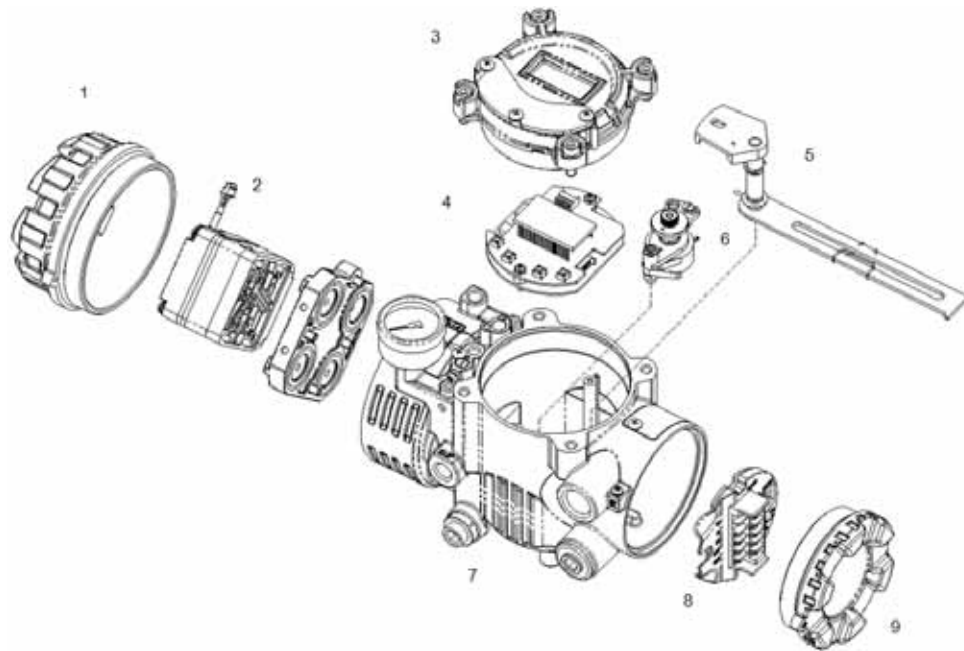
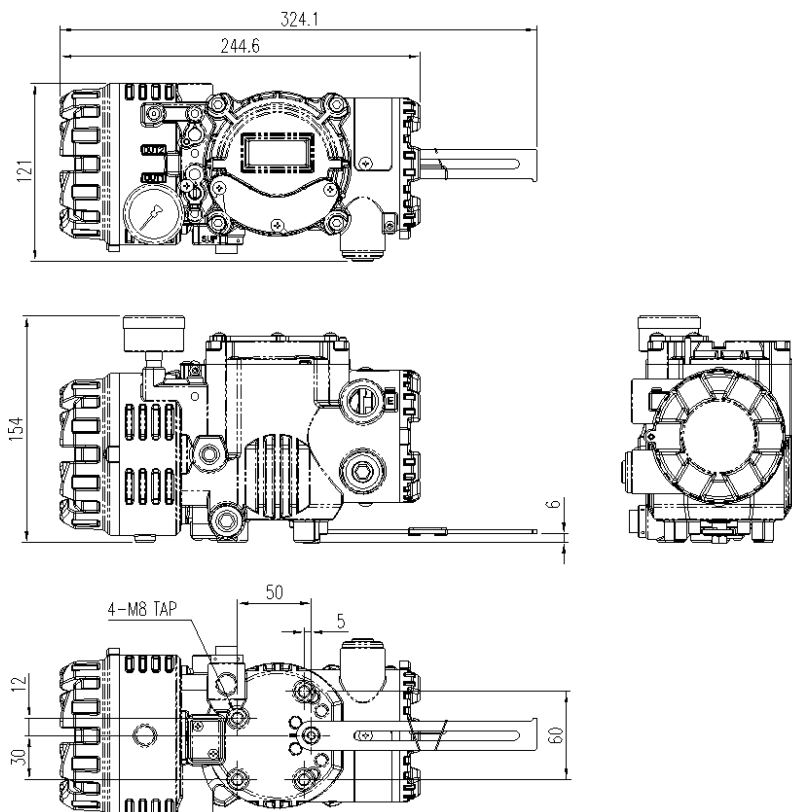

Fig. 2: YT-2600 series exploded view

1. Pilot Cover	6. Potentiometer
2. Pilot Unit	7. Main Body
3. Main Cover	8. Terminal PCB
4. Main PCB	9. Terminal Cover
5. Feedback Lever	

## 2.7 Product Dimension

### 2.7.1 YT-2600L





## 2.7.2 YT-2600R

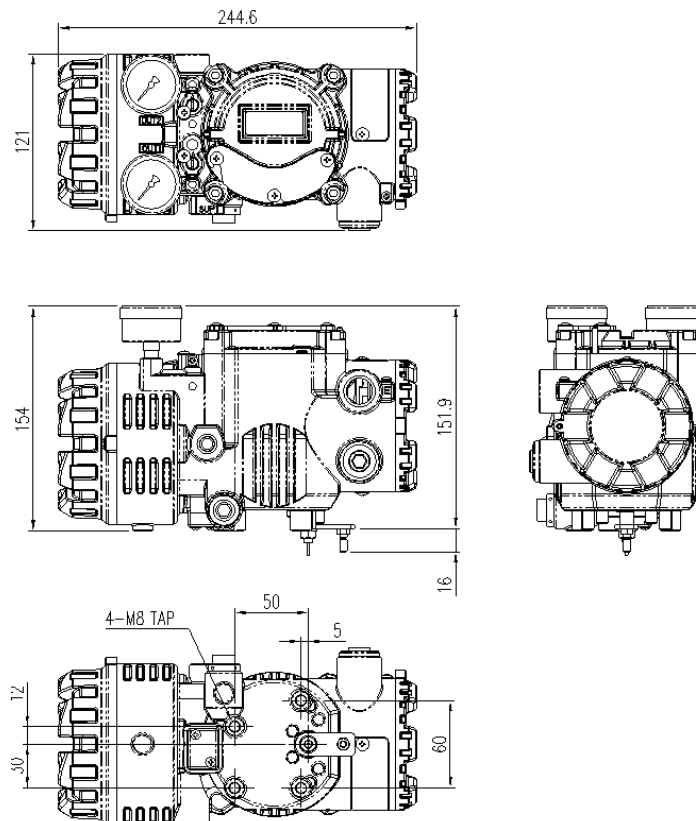

## 3. Installation

### 3.1 Safety

When installing a positioner, please ensure to read and follow safety instructions.



- Any input or supply pressures to valve, actuator, and / or to other related devices must be turned off.
- Use bypass valve or other supportive equipment to avoid entire system “shut down”.
- Ensure there is no remaining pressure in the actuator.

### 3.2 YT-2600L Installation

YT-2600L should be installed on linear motion valves such as globe or gate type which uses spring return type diaphragm or piston actuators. Before proceeding with the installation, ensure following components are available.

- Positioner unit
- Feedback lever and lever spring
- Flange nut (bottom side of YT-2600L)
- 4 pcs x hexagonal headed bolts (M8 x 1.25P)
- 4 pcs x M8 plate washer

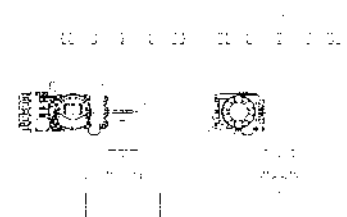

### 3.2.1 Installation Steps

1. Proper bracket must be made in order to adapt the positioner on the actuator yoke. Please consider following important points when a bracket is being designed.



- Positioner's feedback lever must be parallel to the ground at 50% of the valve stroke.
- Feedback lever connection with the pin of the actuator clamp should be installed in such a way that the valve stroke length coincides with the corresponding figure in "mm" marked on the feedback lever. Improper setting may cause poor linearity and may create unnecessary hunting during the operation.

2. Assemble the positioner with the bracket made in previous step by fastening the bolts. Please refer to the backside of the positioner for size of the bolts. The standard bolt size is M8 x 1.25P. Please contact Young Tech Co., Ltd for other bolt sizes.

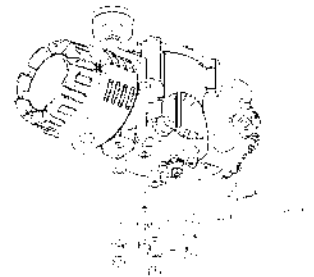

3. Attach the positioner with bracket to the actuator yoke – **DO NOT TIGHTEN POSITIONER COMPLETELY.**

4. Connect positioner's feedback lever to the actuator clamp. The hole gap on the feedback lever is 6.5mm. The connection pin's outer diameter should be less than 6.3mm.

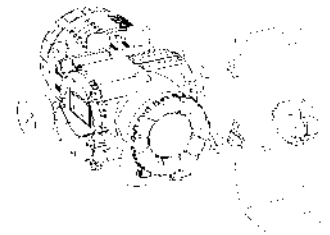

5. Connect supply pressure to the actuator temporarily. Supply enough supply pressure to the actuator in order to position the actuator clamp at 50% of the total valve stroke.
6. Insert connection pin into the feedback lever. The pin should be inserted when the actuator clamp is at 50% of the total valve stroke.

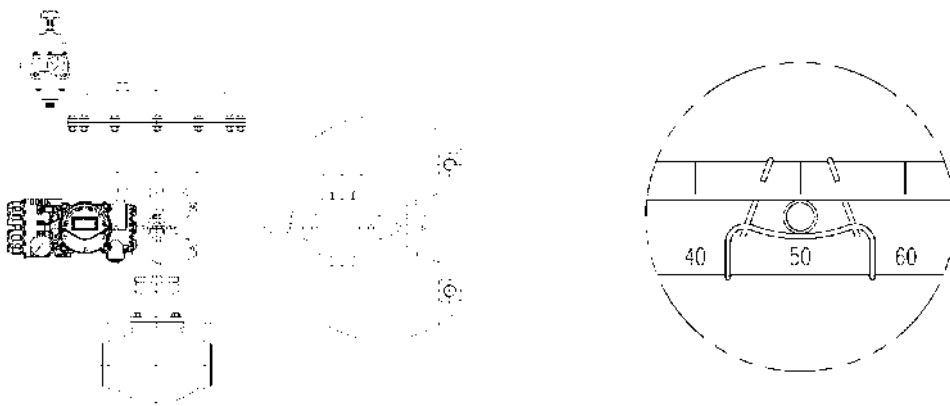

Proper way to connect feedback lever, connection pin, and lever spring

7. Check if feedback lever is parallel to the ground at 50% of the valve stroke. If it is not parallel, adjust the bracket or feedback link bar to make parallel. Improper installation may cause poor linearity and may create unnecessary hunting during the operation.

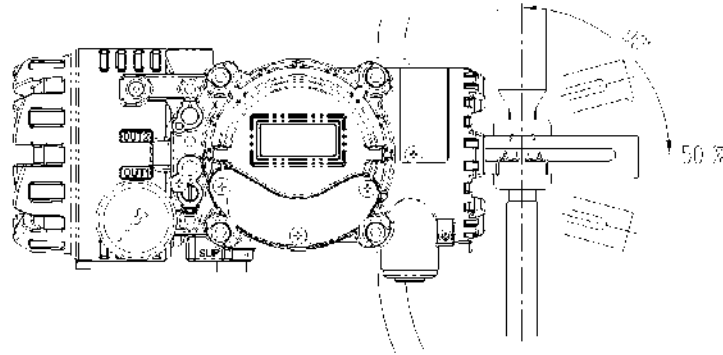

8. Check the valve stroke. The stroke marks are indicated on the feedback lever of the positioner. Position the connection pin at the number on the feedback lever which corresponds to the desired valve stroke. To adjust, move the bracket, the connection pin or both.

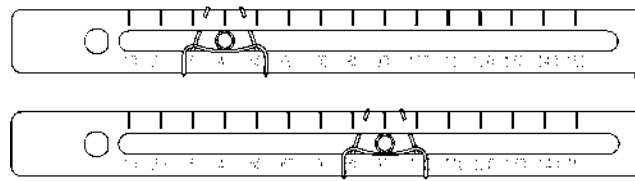

Fig. 3: Pin Insertion when valve stroke is 40mm (up) and is 90mm (bottom)



9. After installing the positioner, operate the valve from 0% to 100% stroke by using direct air to the actuator (manual position). On both 0% and 100%, the feedback lever should not touch the lever stopper, which is located on the backside of the positioner. If the feedback lever touches the stopper, the positioner should be installed further away from the yoke.

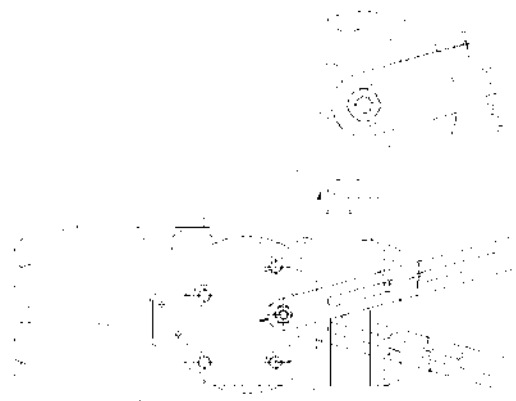

Fig. 4: Feedback lever should not touch lever stopper 0% ~ 100% valve stroke.

10. After the installation, tighten all of the bolts on the bracket, the feedback lever, and the connection pin.

### 3.3 YT-2600R Installation

YT-2600R should be installed on rotary motion valve such as ball or butterfly type which uses rack and pinion, scotch yoke or other type of actuators which stem rotates 90 degrees. Before proceeding with the installation, ensure following components are available.

- Positioner unit
- Fork lever and lever spring
- Standard rotary bracket (included with the positioner)
- 4 pcs x hexagonal headed bolts (M8 x 1.25P)
- 4 pcs x M8 plate washer

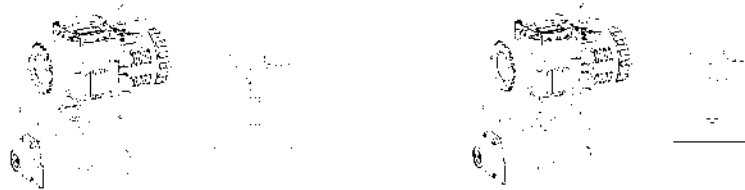

Fig. 5: Fork lever type (left) and NAMUR lever type (right)

#### 3.3.1 Bracket information



Standard bracket (included with the positioner) contains two components. The bracket can be used for both fork lever and NAMUR lever type. The bracket is designed to fit onto the actuator with 20mm stem height (H). If actuator's stem height (H) is 30mm or 50mm, bracket must be adjusted. Please refer to below table how to adjust the bracket.

Actuator stem height (H)	Markings of bolt holes			
	A-L	B-L	A-R	B-R
20mm	H : 20	H : 20, 30	H : 20	H : 20, 30
30mm	H : 30	H : 20, 30	H : 30	H : 20, 30
50mm	H : 50	H : 50	H : 50	H : 50

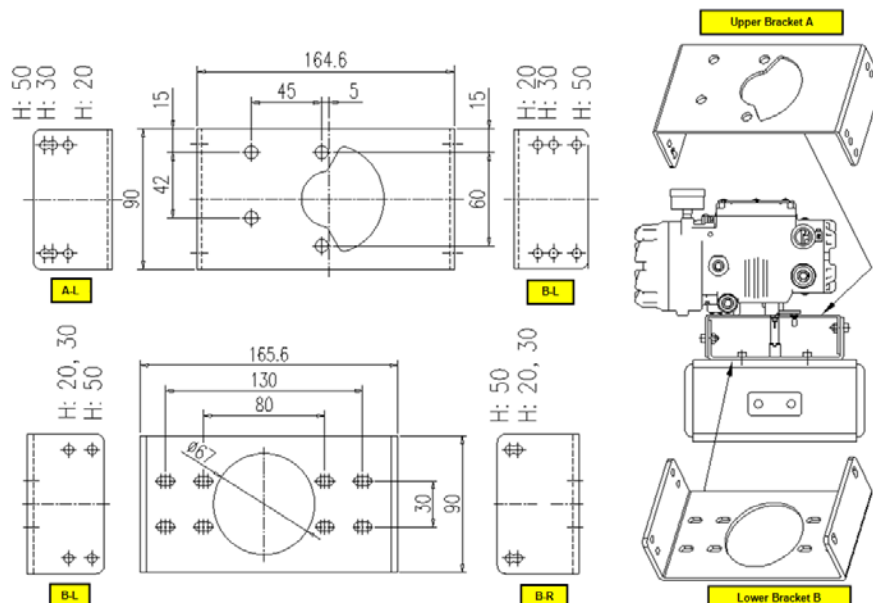

### 3.3.2 Installation Steps

1. Please check the actuator's stem height and adjust the bracket by referring to the bracket table.
2. Attached the bracket onto the actuator. It is recommended to use spring washer so the bolts will not be loosen from vibration.

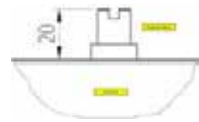

3. Set rotation position of the actuator stem at 0%. For single acting actuator, it is easy to check 0% point by supplying no pressure to the actuator. For double acting actuator, check actuator stem's rotation direction – clockwise or counter-clockwise - by supplying pressure to the actuator.
4. Install the fork lever after setting actuator's stem at 0%. Check the actuator stem's rotation direction – clockwise or counter-clockwise. Installation angle of the fork lever should be 45 degrees in relation to the linear shaft. For NAMUR shaft installation, the angle does not matter.

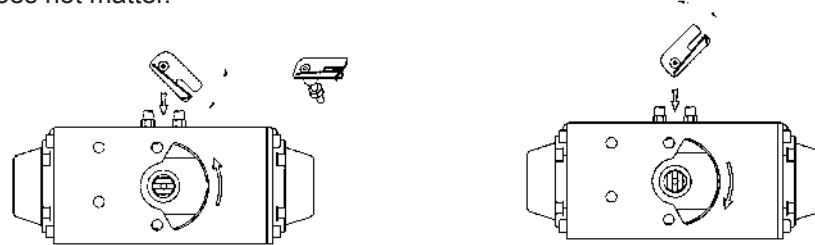
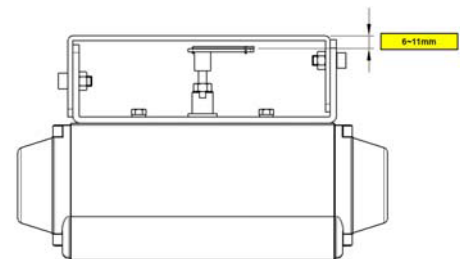

Fig. 6: Counter-clockwise and clockwise rotation.



5. After setting fork lever position, assemble lock nuts which are located on the bottom of the fork lever. Ensure to set the height of the upper fork lever between **6~11mm**, which is lower than the upper bracket's height.



6. Attach the positioner to the bracket. Fix the clamping pin on the main shaft's center of the positioner and insert connection pin into the fork lever slot. This will lock to the fork lever spring. Setting alignment of the main shaft of the positioner and center of the actuator's stem is very important. Poor alignment of the main shaft and the actuator's stem decreases the positioner's durability due to unnecessary forces on the main shaft.

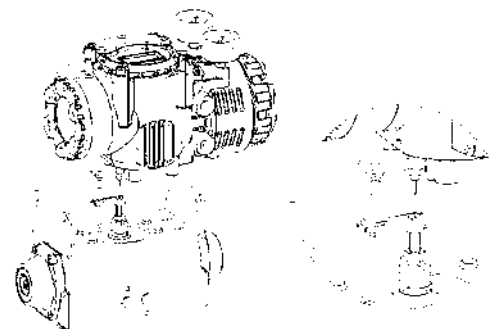

7. Tighten the positioner and the bracket with hexagon-headed bolts and plate washer **after checking the positioner's position.**

## 4. Connections

### 4.1 Safety

- Supply pressure should be clean and dry air – avoiding moisture, oil or dust.
- Always recommended to use air filter regulator (i.e. YT-200 series).
- Young Tech Co., Ltd **has not tested positioner's operation with any other gases other than clean air. Please contact Young Tech Co., Ltd for any questions.**

### 4.2 Supply Pressure Condition

- Dry air with at least 10°C lower than ambient temperature.
- Avoid from dusty air. Positioner's inner filter can only filter 5 micron or larger.
- Avoid oil.
- Comply with ANSI/ISA-57.3 1975(R1981) or ISA S7.3-1975(R1981).
- Supply pressure range is 1.4 ~ 7 kgf/cm<sup>2</sup> (140-700 kPA)
- Set air filter regulator's pressure level 10% higher than actuator's spring range pressure.



### 4.3 Piping Condition

- Ensure inside of pipe is clean of obstructions.
- Do not use pipeline that is squeezed or shows any type of damages.
- Pipeline should have more than 6mm of inner diameter (10mm outer diameter) to maintain flow rate.
- The length of pipeline system should not be extremely long. Longer pipeline system may affect flow rate due to the friction inside of the pipeline.



### 4.4 Connection – Actuator

#### 4.4.1 Single acting actuator

Single acting type positioner is set to use OUT1 port. OUT1 port should be connected with supply pressure port from actuator when using single acting type of spring return actuator.



Fig. 7: Single acting linear (left) and rotary (right) type actuator

#### 4.4.2 Double acting actuator

Double acting type positioner is set to use OUT1 and OUT2 port. As input signal increases, the supply pressure will be supplied through OUT1 port.

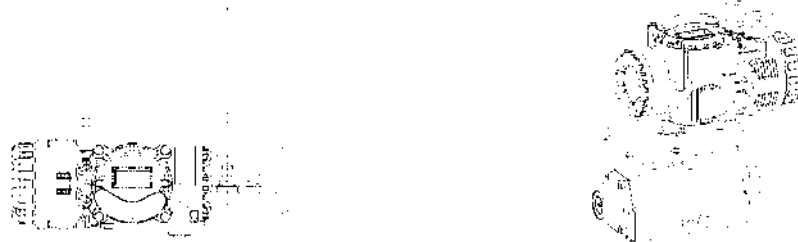
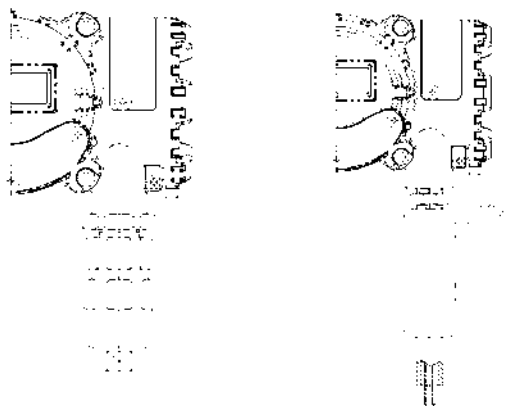

Fig. 8: Double acting linear (left) and rotary (right) type actuator

#### 4.5 Connection – Power

##### 4.5.1 Safety

- When installing in hazardous and explosive gas area, conduit tube or pressure-proof packing union must be used. The compound charging box should be the flameproof type and must be sealed completely.
- Conduit entry connection tap is PF 1/2 or G 1/2.
- Before connecting terminal, ensure that the power is off completely. **Do not open the cover when the power is still alive.**
- Please use ring-type rug to protect against vibration or any other external impact.
- Positioner with PTM options must be supplied 10~28V DC separately. For L/S option, separate 12-24V DC must be supplied. **For both options, it should not exceed 30V DC.**
- Positioner should be grounded.
- Please use twisted cable with conductor section are 1.25mm<sup>2</sup> and that is suitable for 600V (complying to the conductor table of NEC Article 310.) The outer diameter of the cable should be between 6.35 ~ 10mm. Use shield wire to protect against electro-magnetic field and noise.
- Please do not install the cable near high noise equipments, such as high-capacity transformer or motor.



#### 4.5.2 Terminal Overview

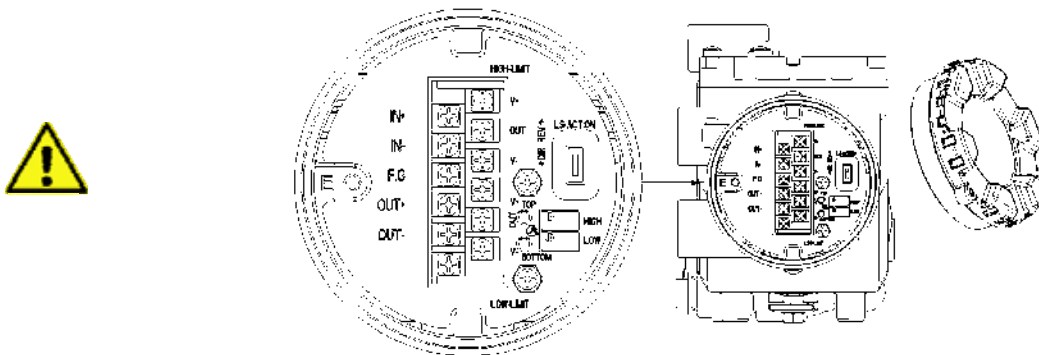
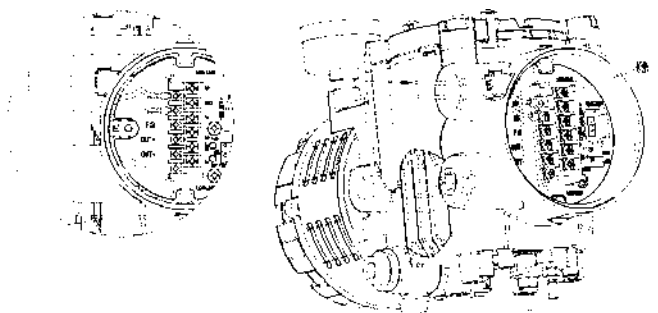

Fig. 9: Positioner Terminal

IN +:	Input Signal (+)	Upper right 3 terminals:	Limit switch 0%
IN -:	Input Signal (-)	Lower right 3 terminals:	Limit switch 100%
OUT+:	Feedback Signal (+)		
OUT-:	Feedback Signal (-)		

##### 4.5.2.1 Input Signal Terminal

1. Open terminal cover by removing stopper bolt using 3mm wrench.
2. Locate two conduit entries on the right hand bottom part of the positioner body. Please use appropriate entry by considering the operating condition. Insert cable with using proper flameproof type packing union
3. Locate terminal of input signal on the left hand bottom side of the positioner. Insert terminal bolts into the conduit entry and secure them with (+) and (-) terminals on the plate. Make sure to tighten bolts with 1.5 Nm (15 kgf/cm<sup>2</sup>) torque. Please check the polarity of the terminals.
4. Close the terminal cover and fasten stopper bolt using 3mm wrench.



##### 4.5.2.2 Feedback Signal Terminal

1. Open terminal cover and locate feedback signal terminals. <Fig.9>
2. Locate terminal of feedback signal and connect (+) and (-) according to the polarity. Make sure to tighten bolts with 1.5 Nm (15 kgf/cm<sup>2</sup>).
3. Close the terminal cover and fasten stopper bolt using 3mm wrench.

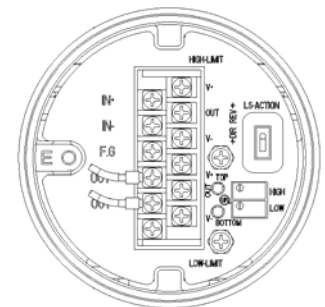



#### 4.5.2.3 Limit Switch Terminal

1. Open terminal cover and locate limit switch terminals. <Fig. 9>
2. Locate terminal of limit switch and connect (+) and (-) according to the polarity. Make sure to tighten bolts with 1.5 Nm (15 kgf/cm<sup>2</sup>).
3. Close the terminal cover and fasten stopper bolt using 3mm wrench.

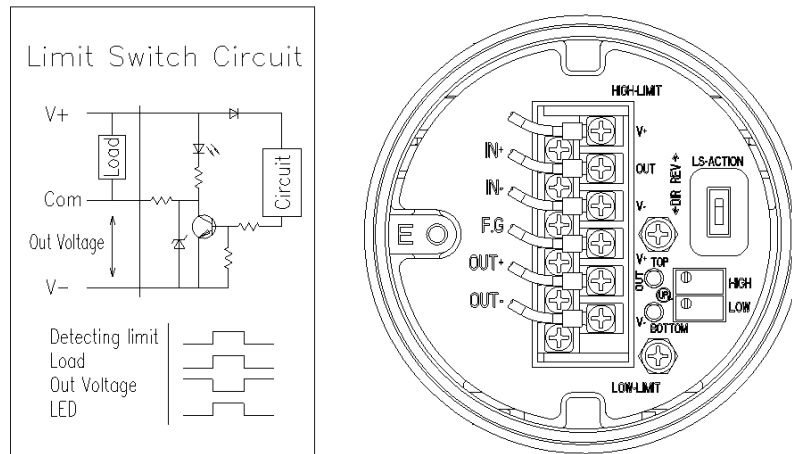

#### 4.5.2.4 Ground

1. Ground must be done before operating the positioner.
2. Open terminal cover and locate ground terminal plate on the right hand bottom side of the terminal plate. The outer cable entry is located at outside of the terminal. Please make sure that the resistance is less than 100ohm.
3. When using external ground, use (+) screw driver to unscrew the ground bolts. Insert outside ground bolts and spring washer into ring type terminal of the ground cables and tighten them with bolts.
4. When using inside ground, use 3mm wrench to loosen locking bolts of the terminal box cover.

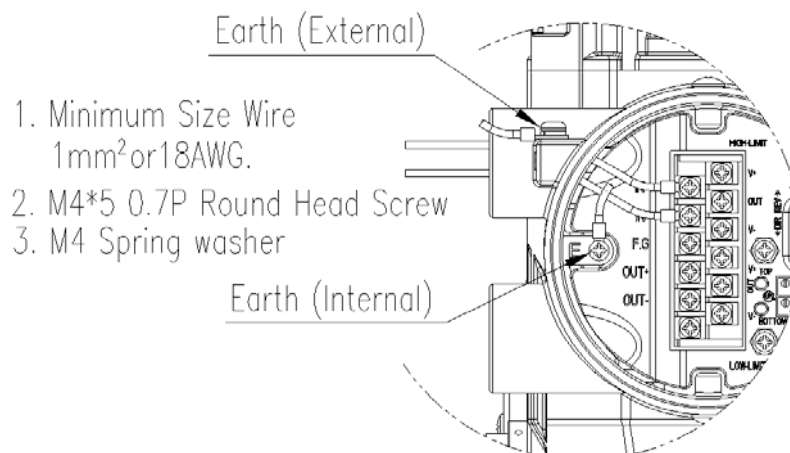

## 5. Adjustments

### 5.1 Limit Switch Adjustment

1. HIGH variable resistor adjusts the sensing point of valve end-point. In case of Direct Action type, it will sense 4mA point, and for Reverse Action type, 20mA of input signal will be its sensing point. Upon sensing, red LED will be lighted.
2. LOW variable resistor adjusts the sensing point of valve zero-point. In case of Direct Action type, it will send 20mA point, and for Reverse Action type, 4mA of input signal will be its sensing point. Upon sensing, red LED will be lighted.
3. If V+ and COM terminals are connected, electric current can be used on limit switch. It can light up control room's lamp or make alarm sound.
4. If V- and COM terminals are connected, electric voltage can be used on limit switch. It can receive signal from a computer.
5. LS-ACTION dip switch enable to switch the action between direct or reverse action.
6. By adjusting variable resistor, limit switch operation range can be set. If it is turn clockwise, range will be widen; if turned in counter-clockwise, range will be shortened. As range adjusts, red LED light will indicate the completion of the adjustment.

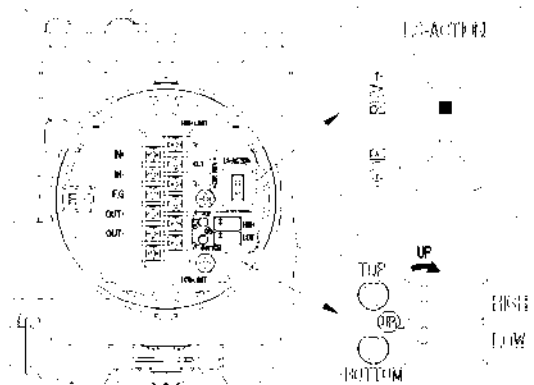

### 5.2 Variable Orifice Adjustment

Hunting can be occurred when the actuator's volume is too small. In order to prevent hunting, orifice can be adjusted. By adjusting the orifice, the flow rate of the supply pressure to actuator can be adjusted. Please use (-) driver to adjust the orifice.

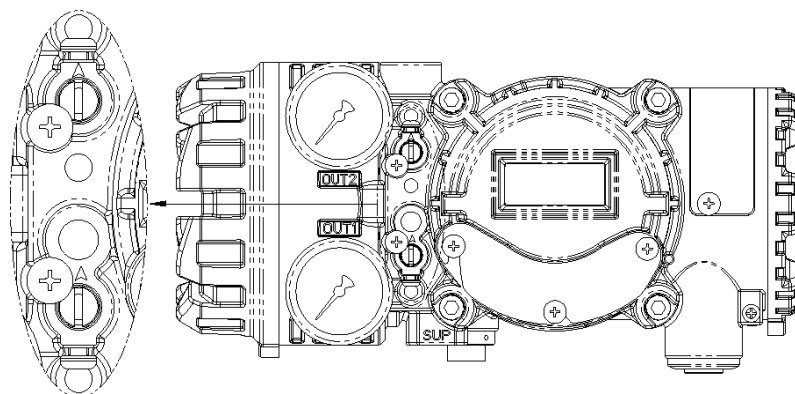

Fig. 10: Variable orifice adjustment  
Clockwise turn: reducing the flow rate

## 6. Operation

### 6.1 Safety



Following process will operate valve and actuator. Before proceed with any AUTO Calibration, please separate valve from the entire system, so AUTO Calibration will affect entire valve process.

### 6.2 Button Description

Positioner has 4 buttons, and they enable to perform various functions.

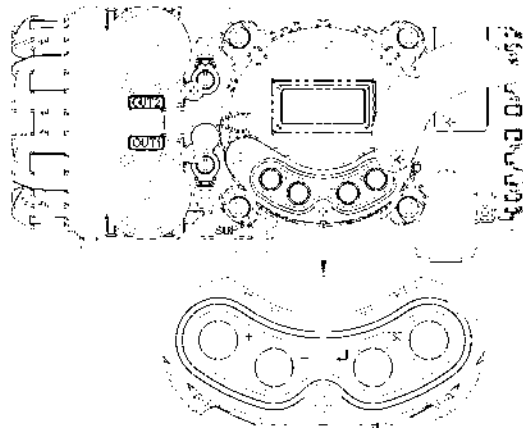

Fig. 11: <ENTER>: Enter to main and sub menus, and save  
<ESC>: Return to previous menu  
<UP> & <DOWN>: Move to next menu, and adjust.

### 6.3 Run Mode (RUN)

After power connection to the positioner, Run Mode will be appeared on positioner's LCD screen within 6 seconds. "RUN" indicates that the positioner adjusts the valve stroke according to the receiving signal. There are six types of display message in "RUN" Mode.



1. Run PV: Process Value - valve stroke %
2. Run SV %: Set Value – input signal 0~100%
3. Run SV mA: Set Value – input signal 4~20mA
4. Run MV: Manipulate Valve – Motor Manipulate Value (digit)
5. Run Vel: Velocity – Current valve stem's velocity (digit)
6. Run Err: Error – Difference between SV and PV (%)

To change display, push <ESC> + <UP> buttons at the same time. The display will change in the order indicated above. If <ESC> + <DOWN> pushed, the order will be appeared in opposite order. By pressing <ESC>, the display will return to "RUN" mode.

### 6.3.1 Auto Calibration (AUTO CAL)

Auto Calibration (AUTO CAL) automatically calibrates the positioner. "AUTO CAL" process takes about 2~3 minutes, and the duration of the process varies upon the size of the actuator. There are 3 types of AUTO CAL.

	Zero Point	End Point	KP, KI, KD	RA / DA
<b>AUTO 1</b>	O	O	X	X
<b>AUTO 2</b>	O	O	O	O
<b>AUTO 3</b>	X	X	O	O



**It is recommend to perform AUTO2 calibration for initial positioner setting.**

#### 6.3.1.1 AUTO1 Calibration (AUTO1)

AUTO1 changes zero and end points; however, KP, KI, KD will not be adjusted. It is recommended to perform AUTO1 when the positioner has been set by the valve manufacturer already, and the field user wants to re-calibrate the positioner.

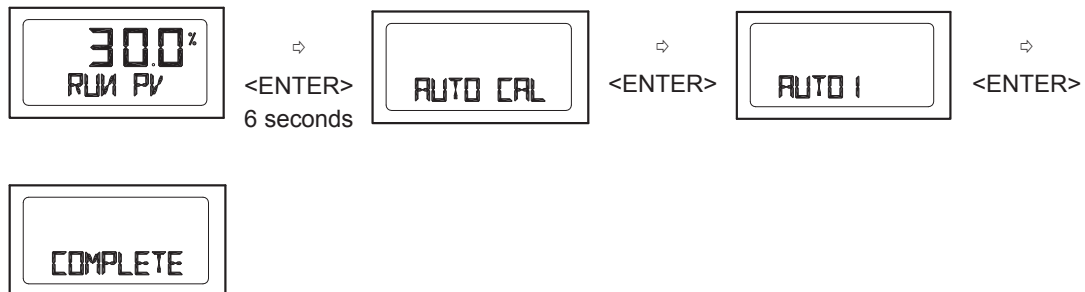

#### 6.3.1.2 AUTO2 Calibration (AUTO2)

AUTO2 changes all of the parameters. It is recommended to perform AUTO2 when the positioner has been installed on the valve for the first time.

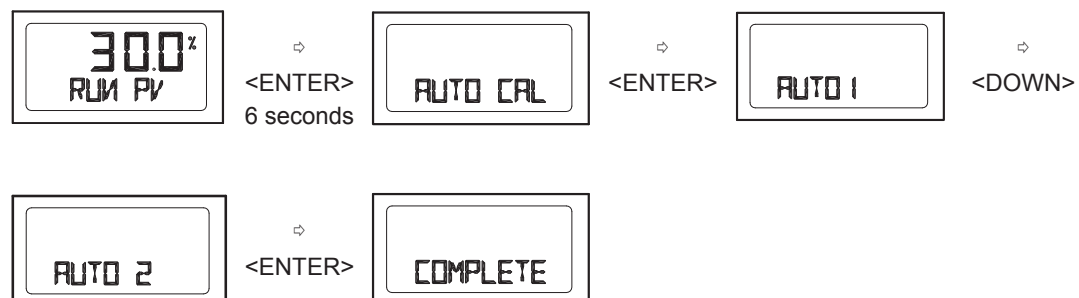

### 6.3.1.3 AUTO3 Calibration (AUTO3)

AUTO3 changes only the valve parameters.

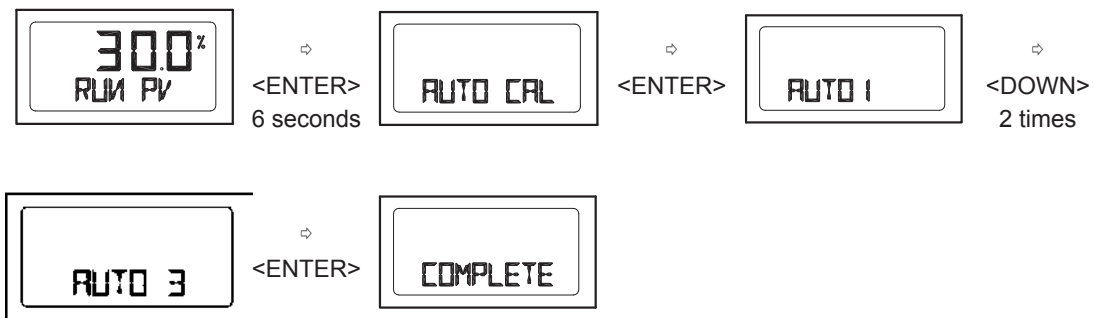

### 6.3.2 Manual Mode (MANUAL)

Manual mode is used to maneuver valve stem manually. During "MANUAL", the positioner bypasses supply air to the actuator. The movement of the stroke does not affect the positioner's save data valves.

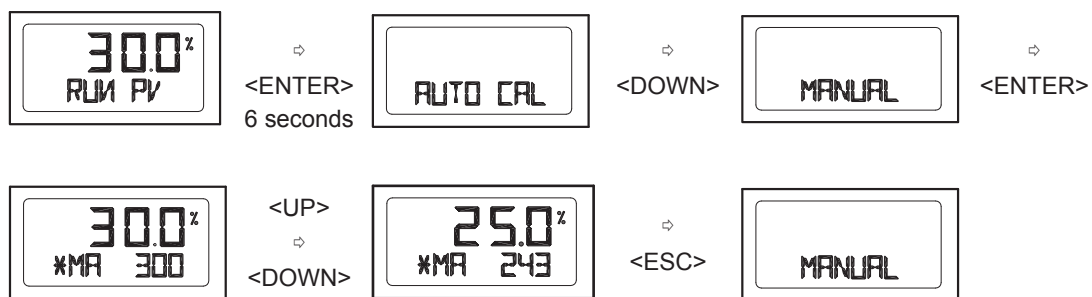

### 6.3.3 Parameter Mode (PARAM)

AUTO CAL optimizes most of the valve actuator control values. However, in some instances, hunting or oscillation may occur when the valve actuator control values are not optimized. Hunting or oscillation can be prevented by adjusting parameter values.



**Once parameter values have been changed, the changed values are being affected as soon as you save the value. To save the changes, please ensure to press "ENTER" button. There is no need to go back to "RUN" mode after changes are being made to observe the changes.**

#### 6.3.3.1 Dead-Zone (dEAdZONE)

Dead-Zone indicates the percentage of error allowance. In case of high level of packing friction, which may cause hunting, creating Dead-Zone can stable the valve operation.

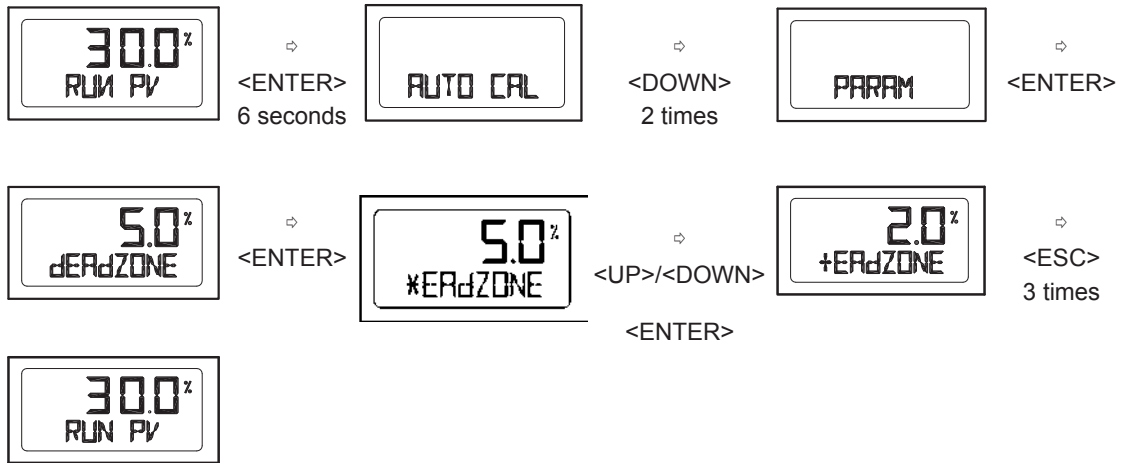

### 6.3.3.2 P1 value (KP1)

P value indicates the ratio of the compensation signal based on the percentage of error allowance. As the value increase, the positioner finds the target value quickly, but it is more likely to have hunting.

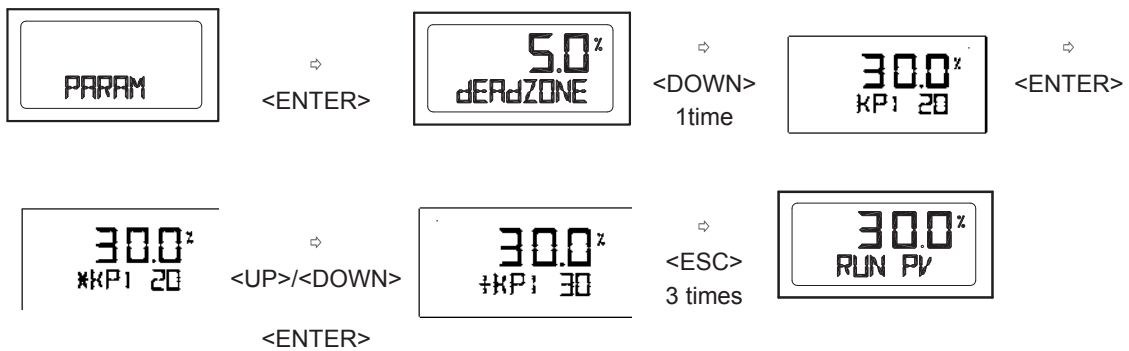

### 6.3.3.3 D1 value (Kd1)

D value indicates the derivative value of the compensation signal based on the percentage of error allowance. As the value increase, it is more likely to have hunting. As the value decreases, it can have poor linearity.

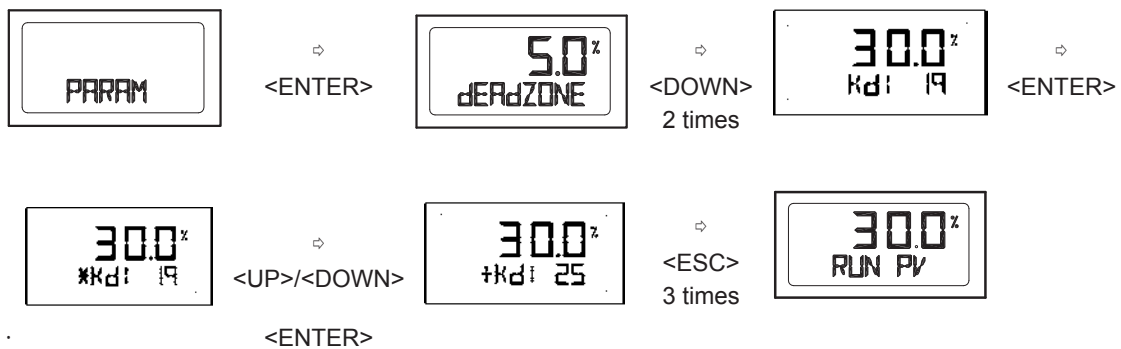

#### 6.3.3.4 P2 (KP2) and D2 (Kd2) values

P2 and D2 values' principles are same as P1 and D1, but these values are applicable for only when input signal is decreasing.

#### 6.3.3.5 P\_ (KP\_) and D\_ (Kd\_) values

P\_ and D\_ values' principles are same as P and D, but these values are applicable only when the positioner's actual stroke reaches its target stroke per input signal.

#### 6.3.3.6 PT1 (PT1) and PT2 (PT2) values

PT value indicates minimum time duration of internal signal. PT1 is for increased input signal, and PT2 is for decreased input signal's PT values.

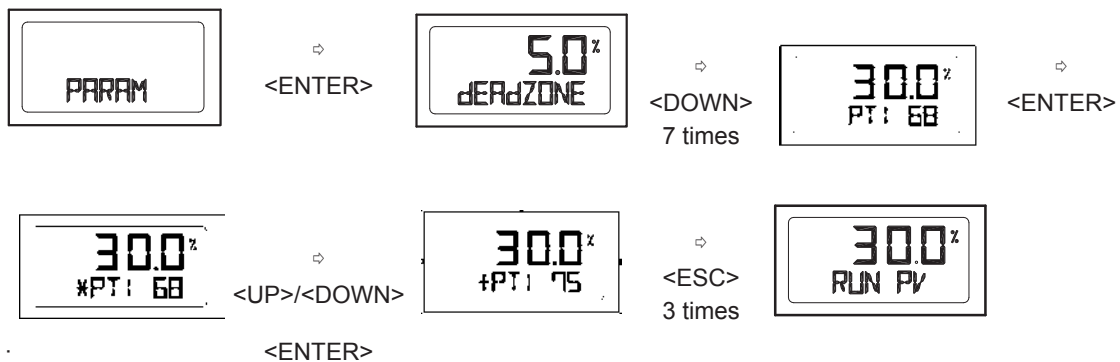

#### 6.3.3.7 Period T (PERIOD T)

Period T indicates the positioner's internal control time interval. As default, positioner will check current position respective to current input signal in every 100 msec.

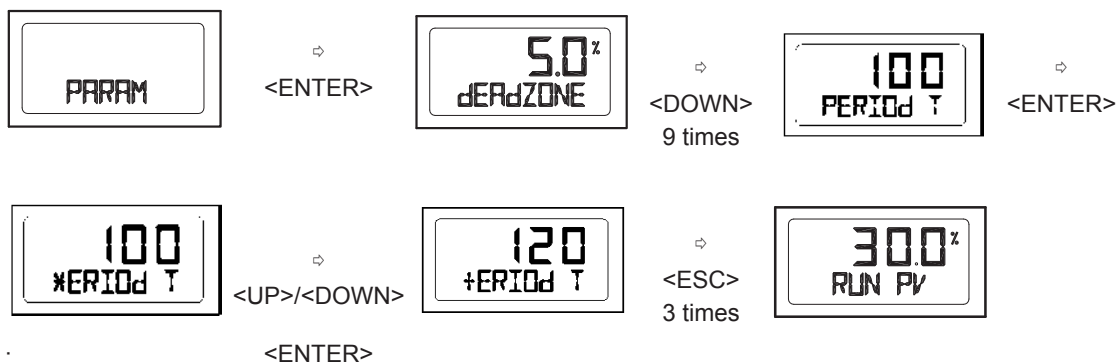

#### 6.3.3.8 Auto DZ (AUTO dZ)

After the auto calibration, the positioner will create deadzone automatically. In some cases, due to the valve packing friction or to some other reasons, deadzone may need to be increased to reduce hunting or oscillation.

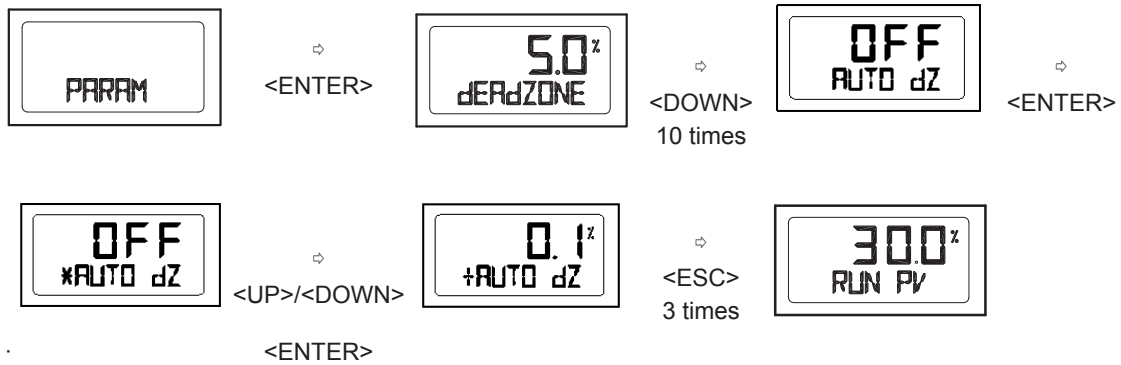

### 6.3.4 Hand Calibration Mode (HAND CAL)

The positioner can be manually calibrated by entering into Hand Calibration Mode.

#### 6.3.4.1 Zero-Point (PV\_ZERO) and End-Point (PV\_END) for Valves

PZ\_ZERO adjusts the zero point of the valve, and PV\_END adjusts the end point of the valve.

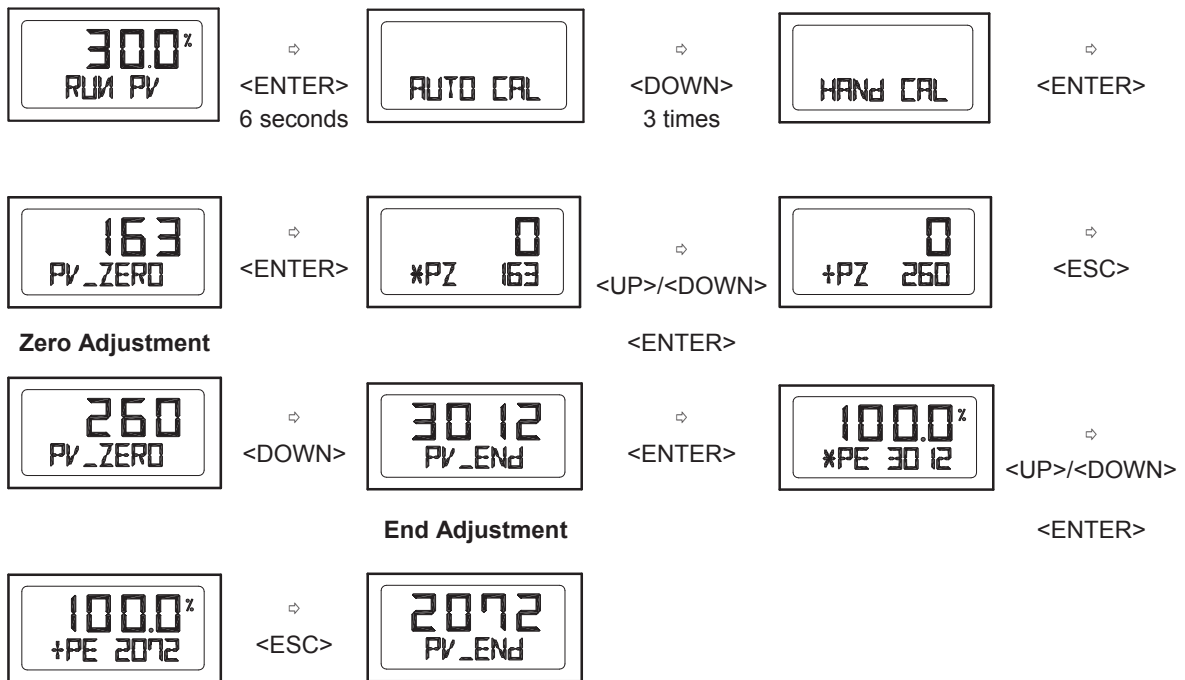

#### 6.3.4.2 Zero-Point (TR\_ZERO) and End-Point (TR\_END) for Transmitter

TR\_ZERO adjusts the zero point of the transmitter (4-20mA feedback), and TR\_END adjusts the end point of the transmitter (4-20mA feedback)

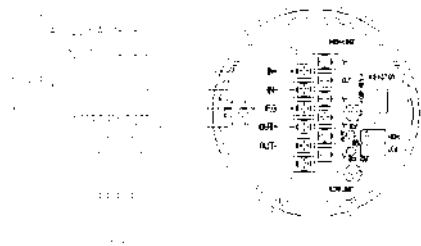



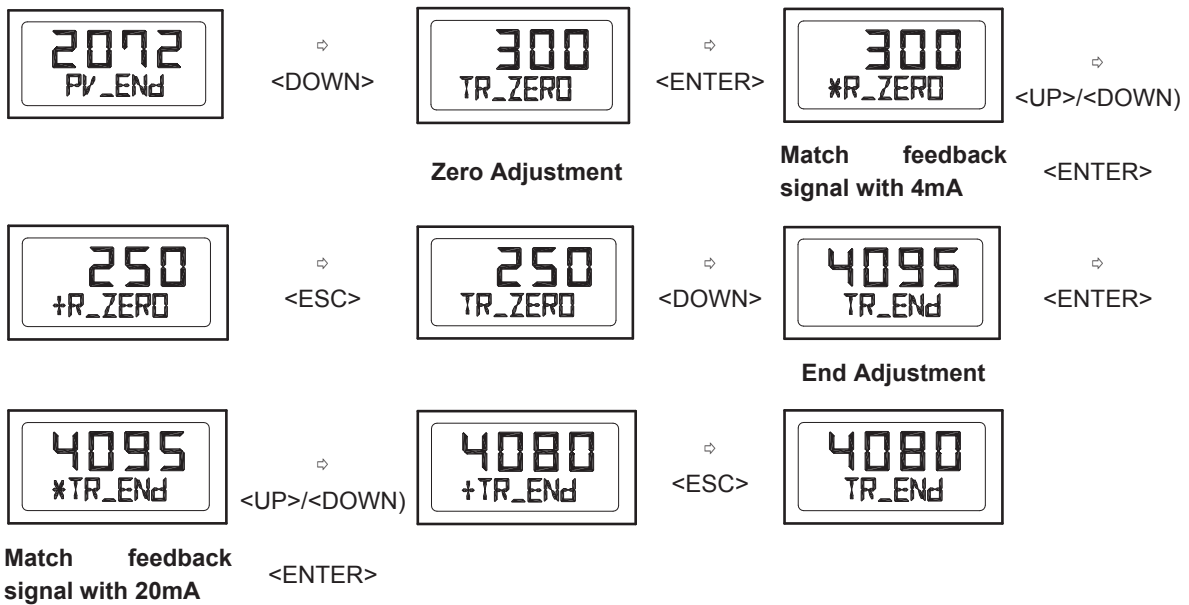

#### 6.3.4.3 End-Point Ratio for Valve (PE\_TRIM)

When reverse acting operating is used, End-Point can be adjusted within 10% of total valve stroke, without adjusting valve's zero point.

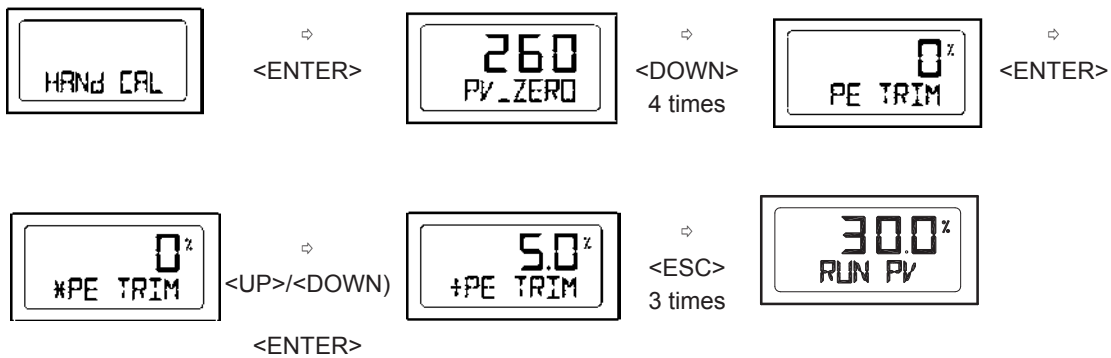

#### 6.3.4.4 Normal / Reverse Feedback Signal (TR\_NORM / REV)

The feedback signal from the positioner can be viewed as normal or as reverse.

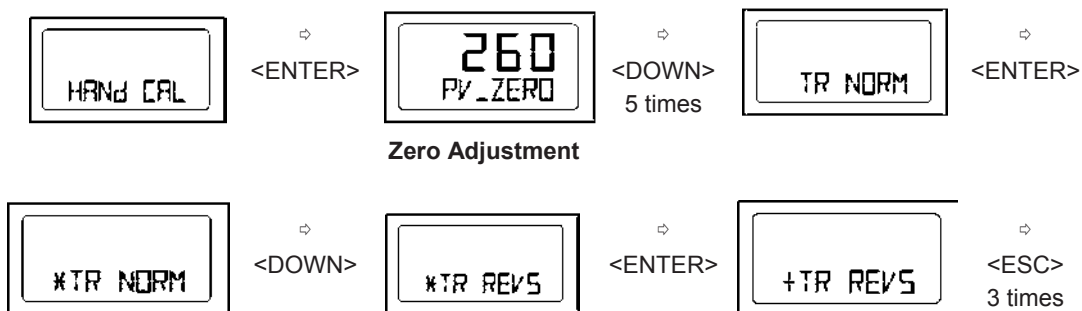



### 6.3.4.5 Normal / Reverse HART Signal (HT\_NORM / REVS)

HART signal from the positioner can be viewed as normal or as reverse.

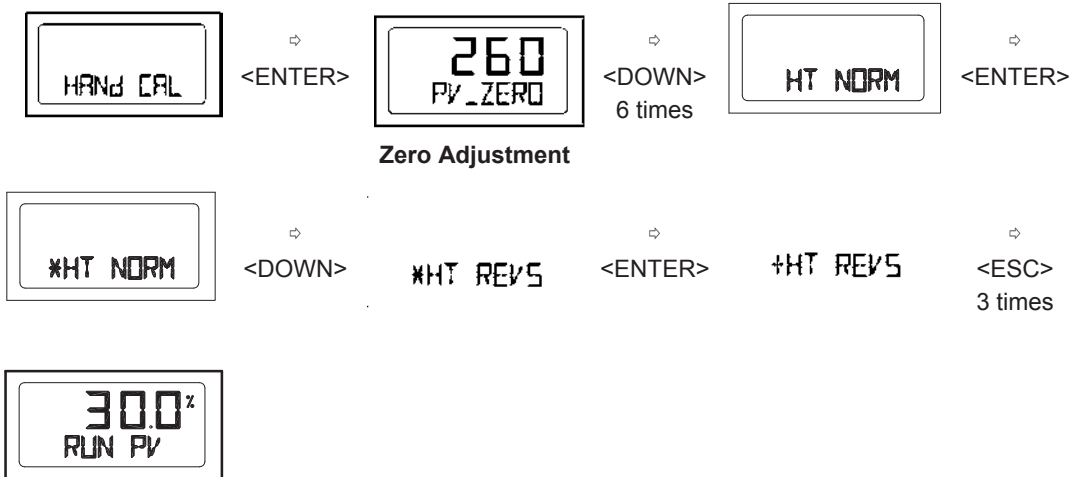

### 6.3.5 Valve Mode (VALVE)

#### 6.3.5.1 Acting Adjustment (ACT)

The positioner can be set as Direct Action (DA) or Reverse Action (RA).

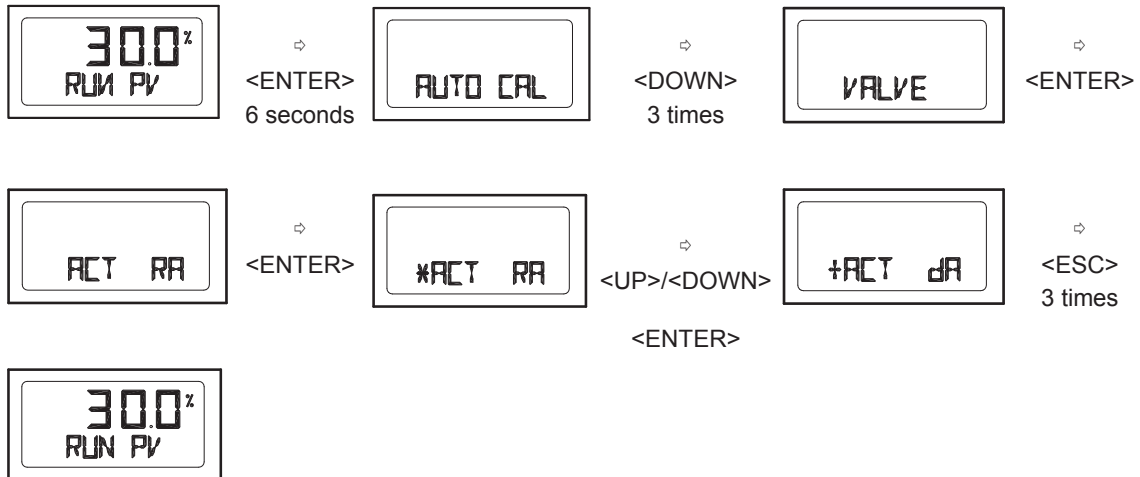

#### 6.3.5.2 Characteristic Adjustment (CHAR)

The valve characteristic can be set on the field's requirement. There are 3 types of characteristics – linear (LIN), equal percentage (EQ), and quick open (QO).

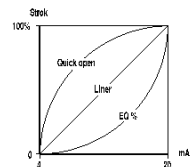

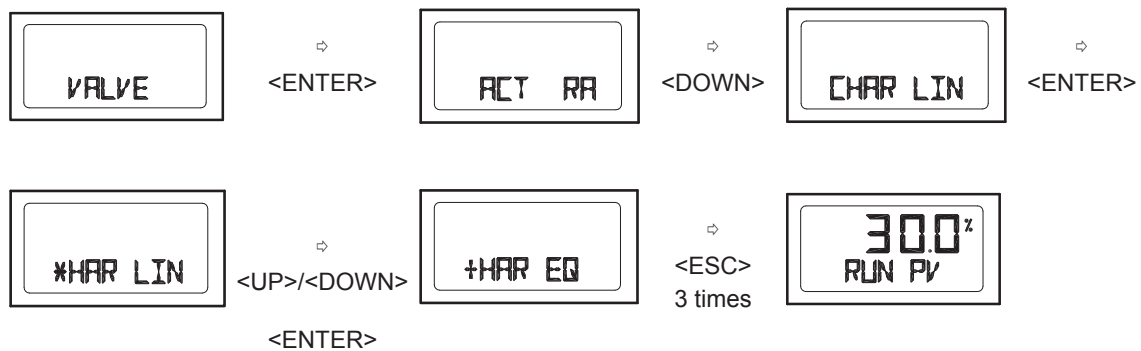

### 6.3.5.3 User Characteristics (USER SET)

In case positioner requires a specific characteristic, the valve characteristic curve can be made by selecting up to 16 points of the curve.

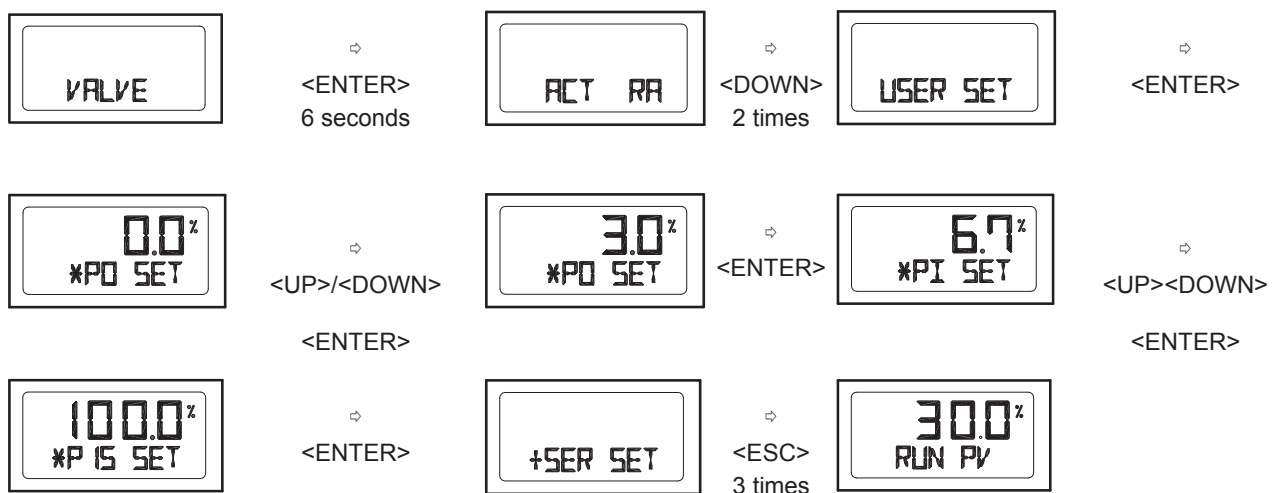

Repeat step if necessary

### 6.3.5.4 Tight Shut Open (TSHUT OP)

Tight Shut Open allows the valve to open completely as the input signal reaches around 20mA.

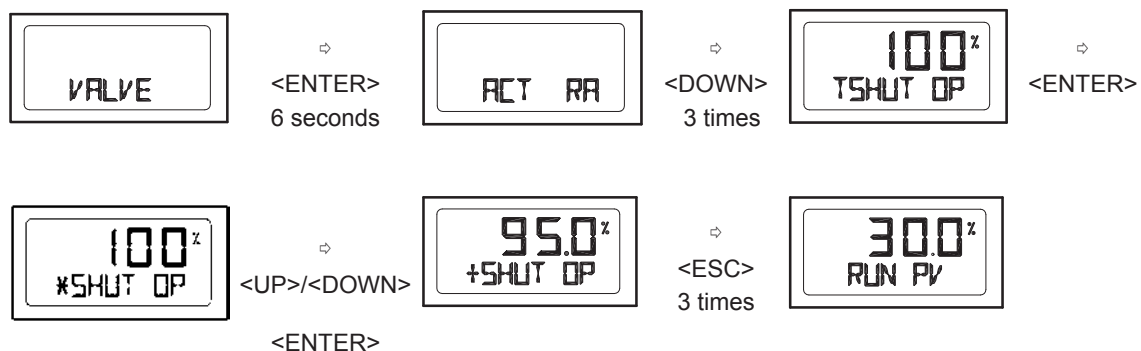

### 6.3.5.5 Tight Shut Close (TSHUT CL)

Tight Shut Close allows the valve to close completely as the input signal reaches around 4mA.

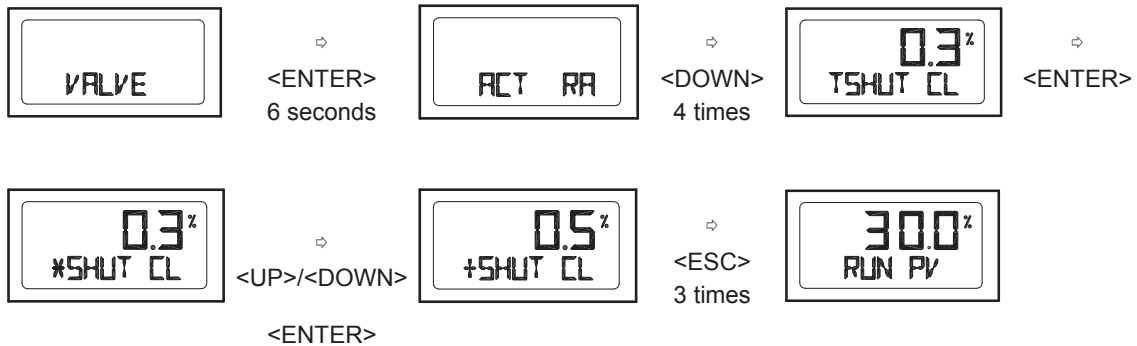

### 6.3.5.6 Split Range Mode (SPLIT)

The valve can be operated by split range control – 4~12mA or 12~20mA.

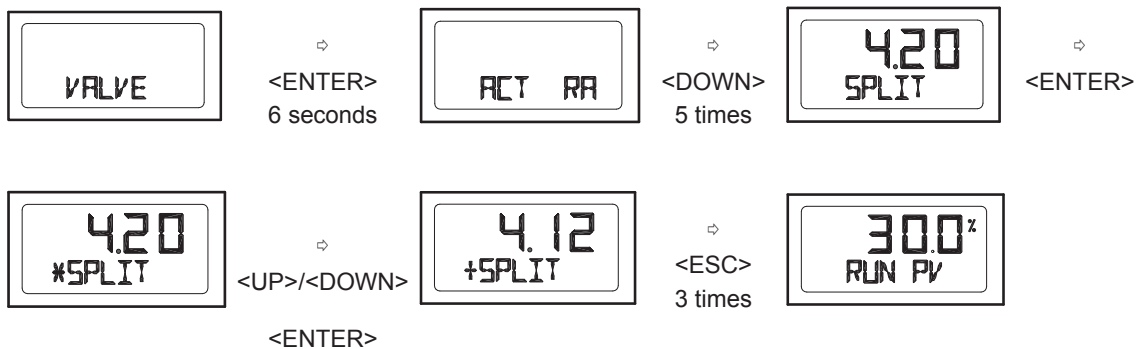

### 6.3.5.7 Interpolation Mode (ITP OFF / ON)

Positioner can control the valve accurately if the feedback lever angle range is within designed range. For some instance, the angle exceeds the suggested range angle. Positioner can reduce the error through interpolation.

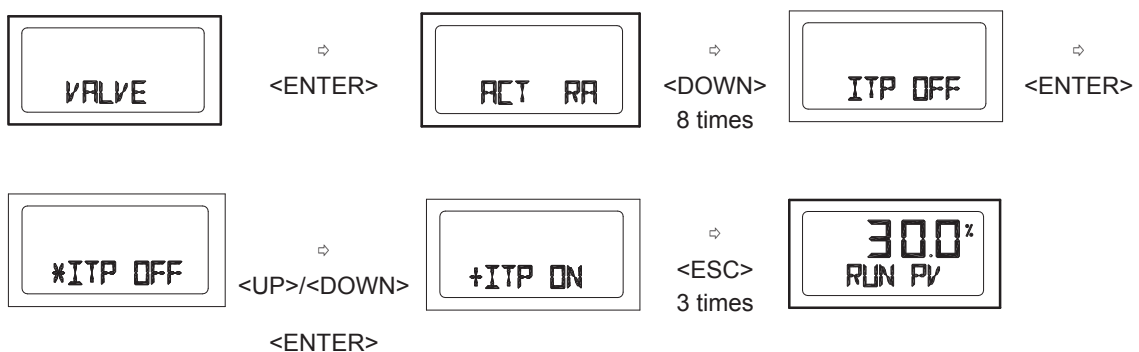

### 6.3.6 View Mode (VIEW)

Different information can be shown on the positioner's LCD.



	Description
<b>YT-2600L</b>	Positioner model
<b>VERSION</b>	Main software version
<b>HART V</b>	HART protocol version
<b>POL Addr</b>	HART protocol channel address
<b>0Y 0d</b>	Total used time duration. If a unit was used less than 1 minute, the time will not accumulate.
<b>FULL_OP</b>	Time elapsed for valve to fully open
<b>FULL_CL</b>	Time elapsed for valve to fully close.
<b>VM NOR</b>	Type of valve stroke on LCD. (in percentage or in value)
<b>Erro</b>	Error code or warning message.
<b>ABS</b>	Absolute resistance value.

## 7. Error and Warning Code

### 7.1 Error code

Error Code	Code Description and Cause	Action
<b>MT ERR L</b>	<ul style="list-style-type: none"> <li>➤ Positioner is improperly installed.</li> <li>➤ Positioner is not parallel to the ground at 50% point. Lever is at lower position than actual 50% point.</li> </ul>	<ul style="list-style-type: none"> <li>➤ Re-install the positioner.</li> <li>➤ Ensure the feedback lever does not touch the lever stopper at 0% and 100%.</li> </ul>
<b>MT ERR H</b>	<ul style="list-style-type: none"> <li>➤ Positioner is improperly installed.</li> <li>➤ Positioner is not parallel to the ground at 50% point. Lever is at higher position than actual 50% point.</li> </ul>	<ul style="list-style-type: none"> <li>➤ Re-install the positioner.</li> <li>➤ Ensure the feedback lever does not touch the lever stopper at 0% and 100%.</li> </ul>
<b>CHK AIR</b>	<ul style="list-style-type: none"> <li>➤ Valve does not operate when positioner receive "Full Open" signal during the auto calibration.</li> </ul>	<ul style="list-style-type: none"> <li>➤ Check supply pressure level.</li> </ul>

<b>RNG ERR</b>	<ul style="list-style-type: none"> <li>➤ Operating angle is too small due to improper positioner installation.</li> </ul>	<ul style="list-style-type: none"> <li>➤ Adjust bracket so the positioner can be mounted closer to actuator.</li> </ul>
<b>C</b>	<p>Error of 10% or more persists more than 1 minute.</p> <ul style="list-style-type: none"> <li>➤ No valve movement.</li> <li>➤ High level of valve friction</li> <li>➤ Changes in setting pressure of actuator.</li> </ul>	<ul style="list-style-type: none"> <li>➤ Perform BIAS calibration.</li> <li>➤ Check setting pressure of actuator.</li> </ul>
<b>D</b>	<p>I-value reaches at maximum or minimum limit.</p> <ul style="list-style-type: none"> <li>➤ Changes in valve friction.</li> <li>➤ Changes in setting pressure of actuator.</li> </ul>	<ul style="list-style-type: none"> <li>➤ Perform auto calibration.</li> <li>➤ Check setting pressure of actuator.</li> </ul>

## 7.2 Warning code

<b>Warning Code</b>	<b>Description</b>	<b>Action</b>
<b>B</b>	<ul style="list-style-type: none"> <li>➤ Pv Span – Pv Zero range is below 500.</li> <li>➤ The angle of feedback lever is too small.</li> </ul>	<ul style="list-style-type: none"> <li>➤ Re-install the positioner.</li> <li>➤ Ensure the feedback lever does not touch the lever stopper at 0% and 100%.</li> <li>➤ After re-installation, perform AUTO1.</li> </ul>
<b>F</b>	<ul style="list-style-type: none"> <li>➤ Full open/close elapsed time is less than 1 second.</li> <li>➤ Actuator size is too small.</li> </ul>	<ul style="list-style-type: none"> <li>➤ Use variable orifice.</li> <li>➤ Use larger actuator.</li> </ul>
<b>G</b>	<ul style="list-style-type: none"> <li>➤ Pv is below 100.</li> <li>➤ The angle of feedback lever is too large.</li> </ul>	<ul style="list-style-type: none"> <li>➤ Re-install the positioner.</li> <li>➤ Ensure the feedback lever does not touch the lever stopper at 0% and 100%.</li> <li>➤ After re-installation, perform AUTO1</li> </ul>
<b>H</b>	<ul style="list-style-type: none"> <li>➤ Pv is over 4000.</li> <li>➤ The angle of feedback lever is too large.</li> </ul>	<ul style="list-style-type: none"> <li>➤ Re-install the positioner.</li> <li>➤ Ensure the feedback lever does not touch the lever stopper at 0% and 100%.</li> <li>➤ After re-installation, perform AUTO1</li> </ul>

## 8. Main Software Map

